

maten in mm
sept. 2013

pas- en arm  
met kader  
30 min. b.v.t.

54mm dik  
binnendraaiend

Blad:  
**954**

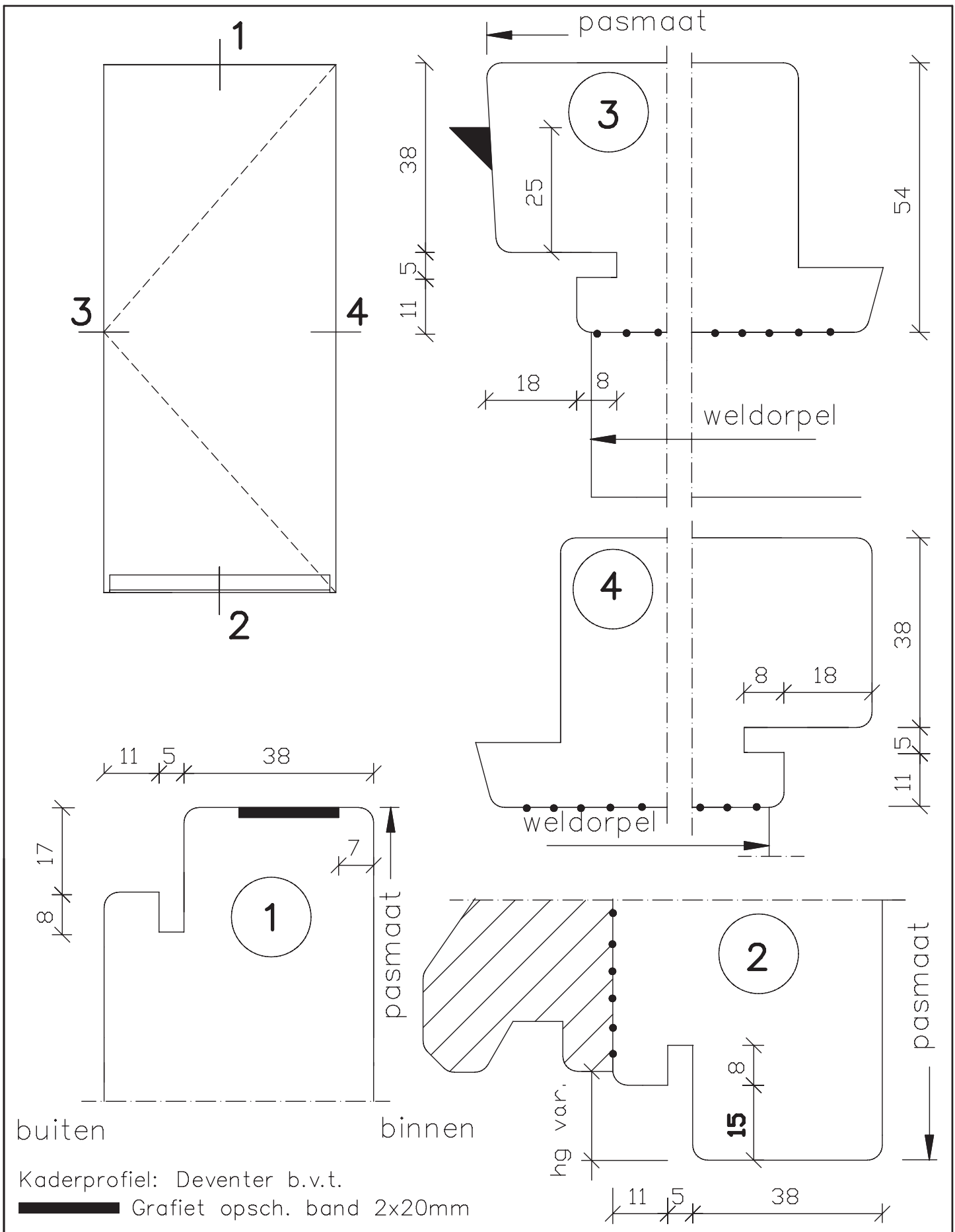

Kaderprofiel: Deventer b.v.t.  
 Grafiet opsch. band 2x20mm



	pas- en arm met kader 30 min. b.v.t.	Blad: 954
maten in mm	54mm dik binnendraaiend	H
sept. 2013		

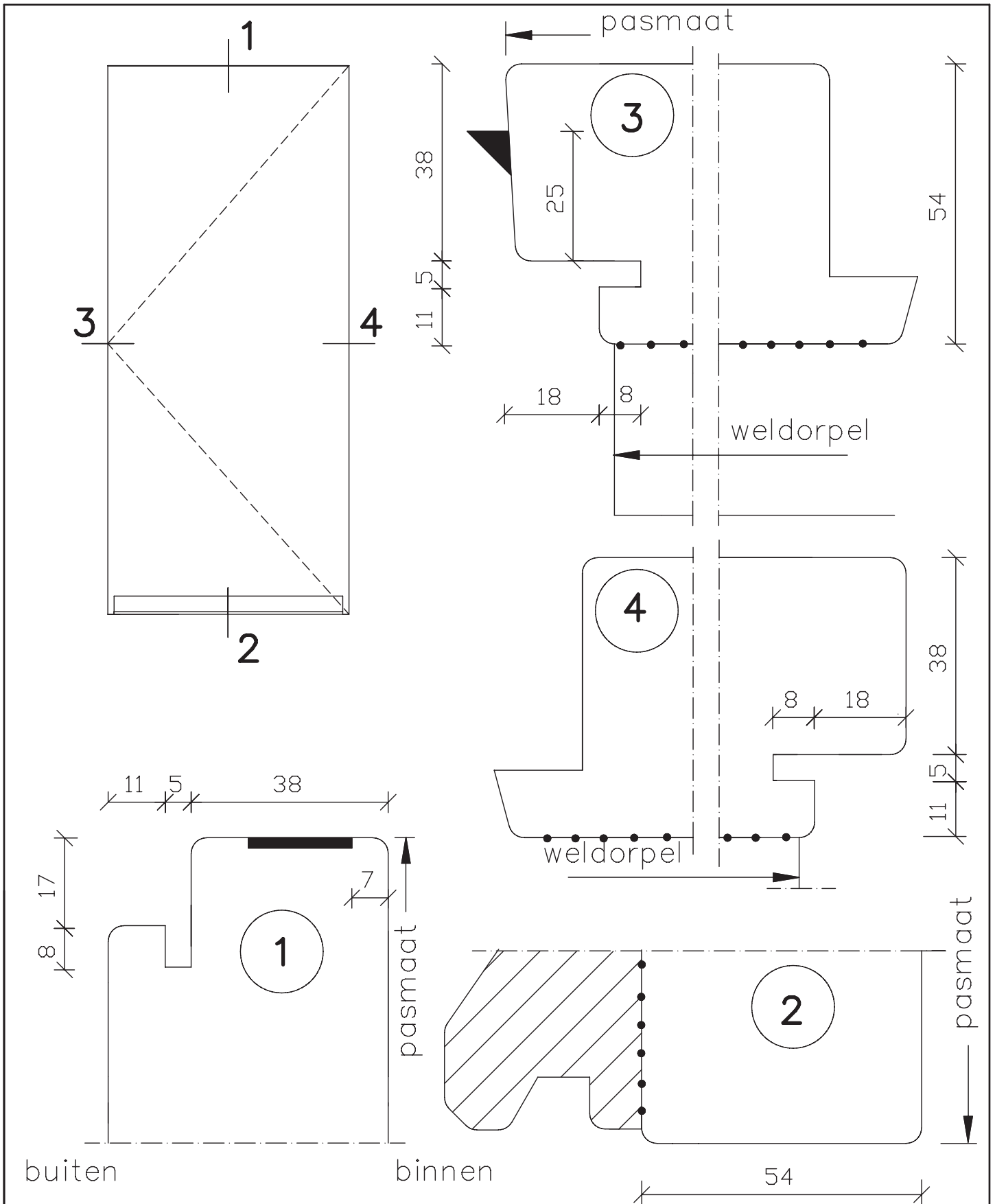

Kaderprofiel: Deventer b.v.t.

 Grafiet opsch. band 2x20mm



maten  
in mm

sept.  
2013

pas- en arm  
met kader  
30 min. b.v.t.  
54mm dik  
binnendraaiend

Blad:  
**954**  
**S**

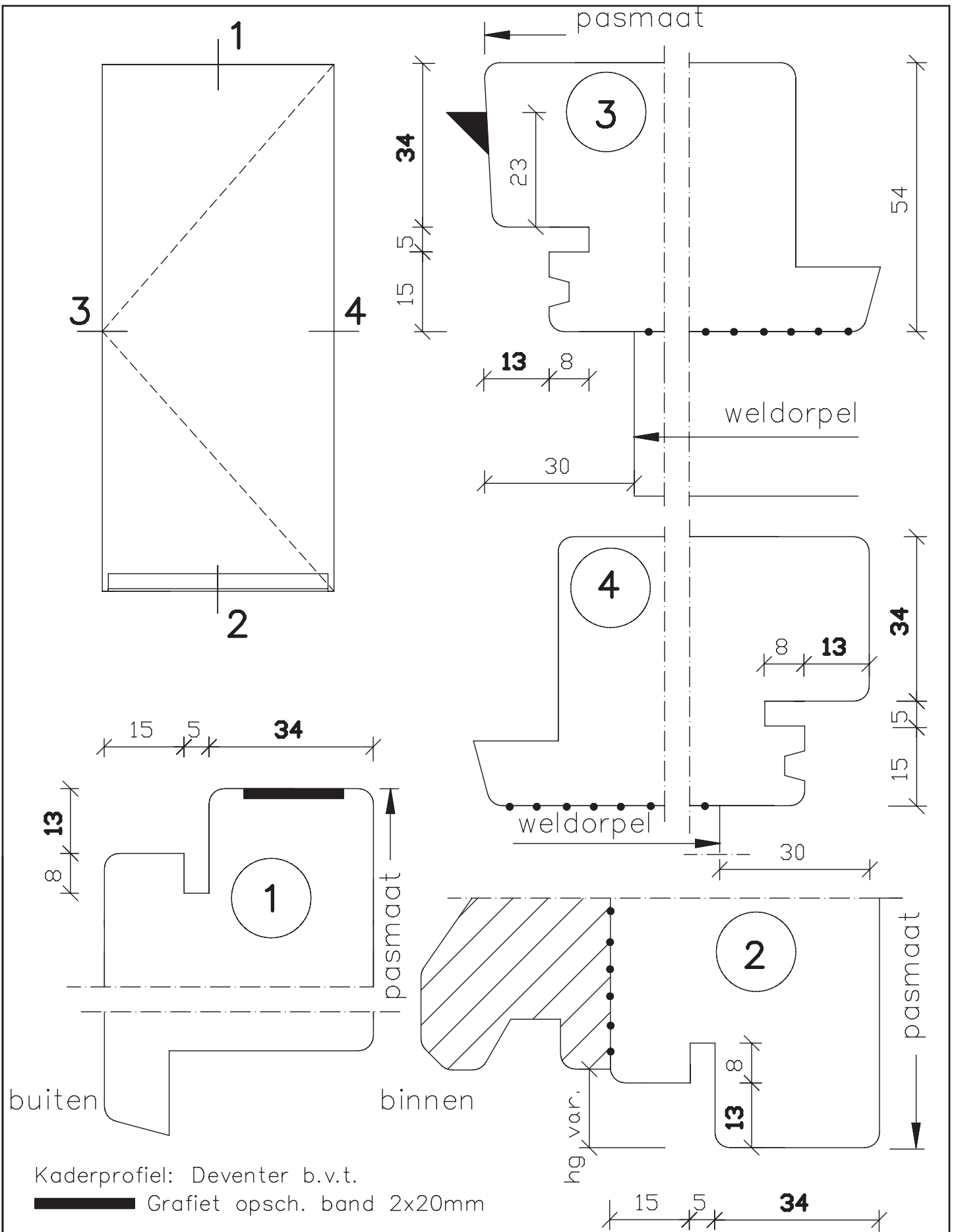

maten in mm
sept. 2013

pas- en arm  
met kader  
30 min. b.v.t.  
-indicatief-  
54mm dik  
binnendraaiend

Blad:  
**956**

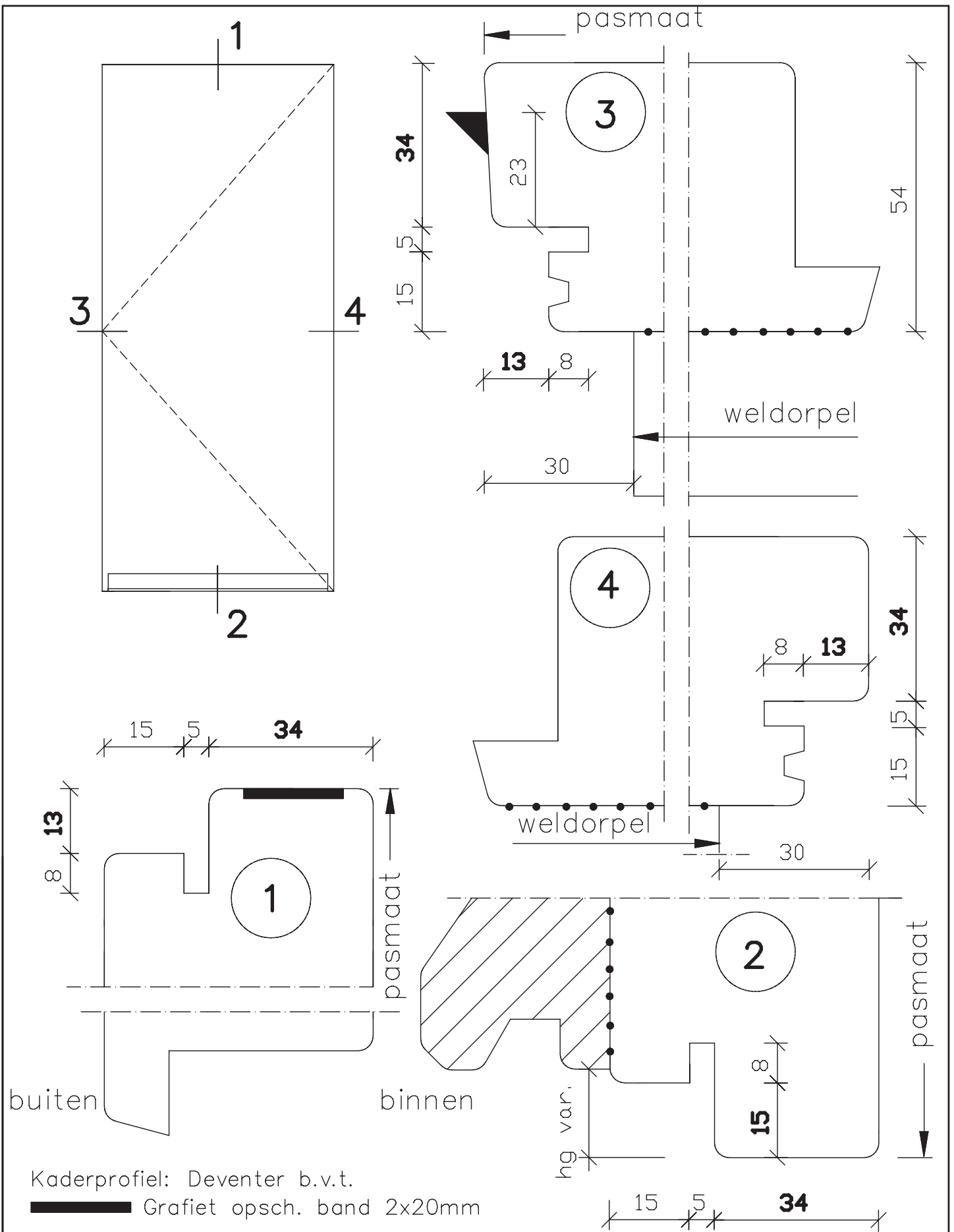

maten  
 in mm  
 sept.  
 2013

pas- en arm  
 met kader  
 30 min. b.v.t.  
 -indicatief-  
 54mm dik  
 binnendraaiend

Blad:  
**956**  
**H**



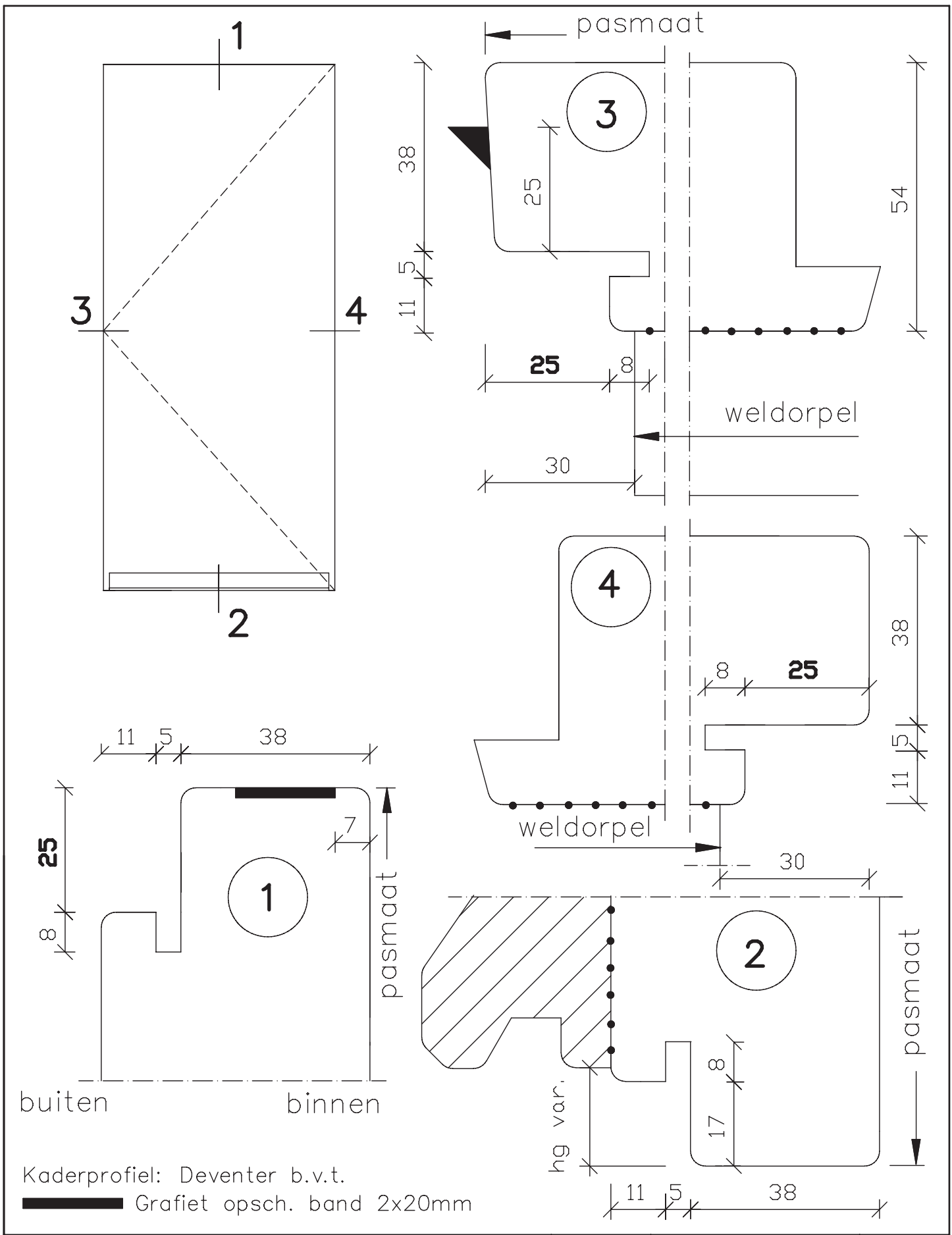

	pas- en arm met kader 30 min. b.v.t.	Blad: 957
maten in mm		
sept. 2013	54mm dik binnendraaiend	

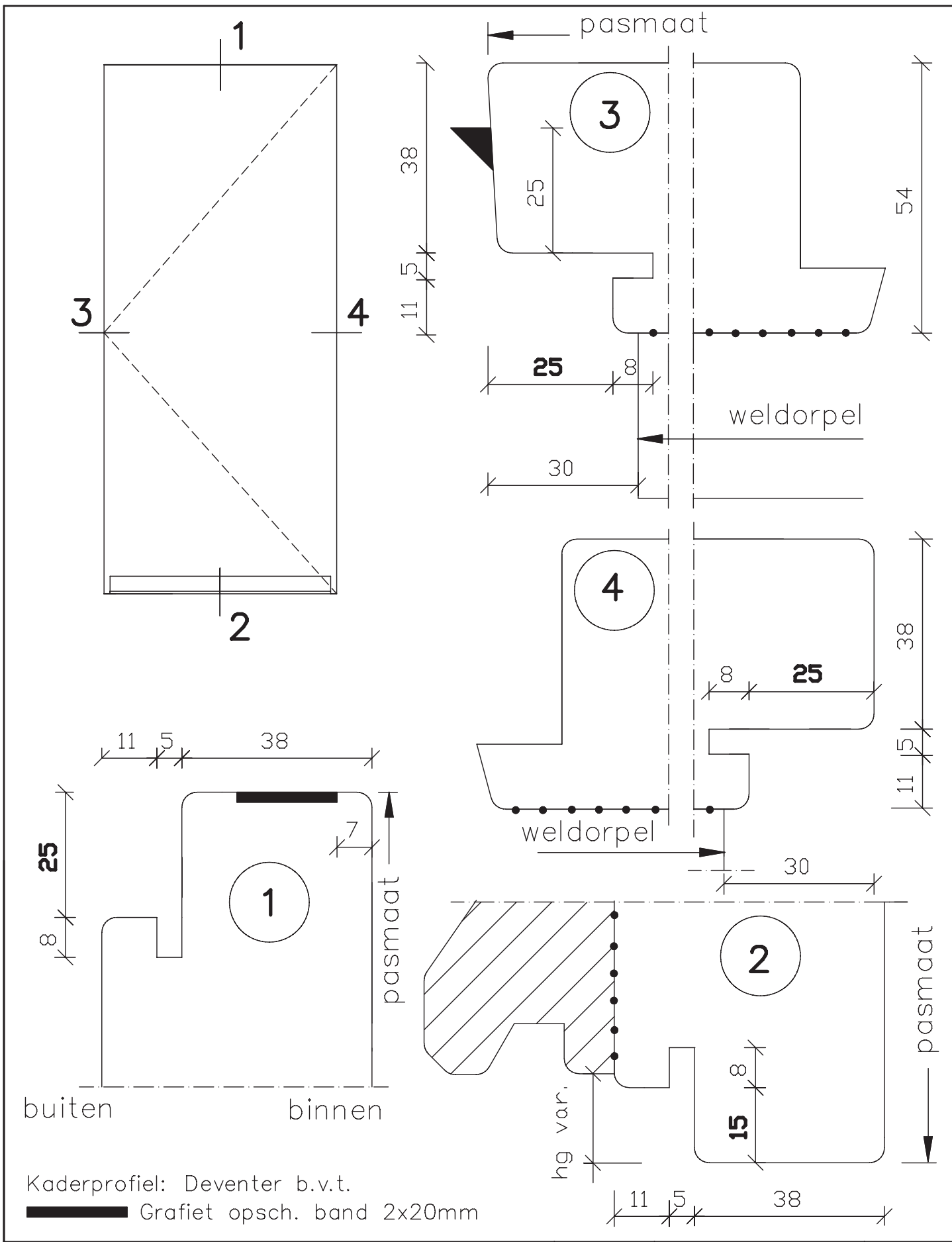

Kaderprofiel: Deventer b.v.t.

Grafiet opsch. band 2x20mm



	pas- en arm met kader 30 min. b.v.t.	Blad: <b>957</b> H
maten in mm	54mm dik binnendraaiend	
sept. 2013		



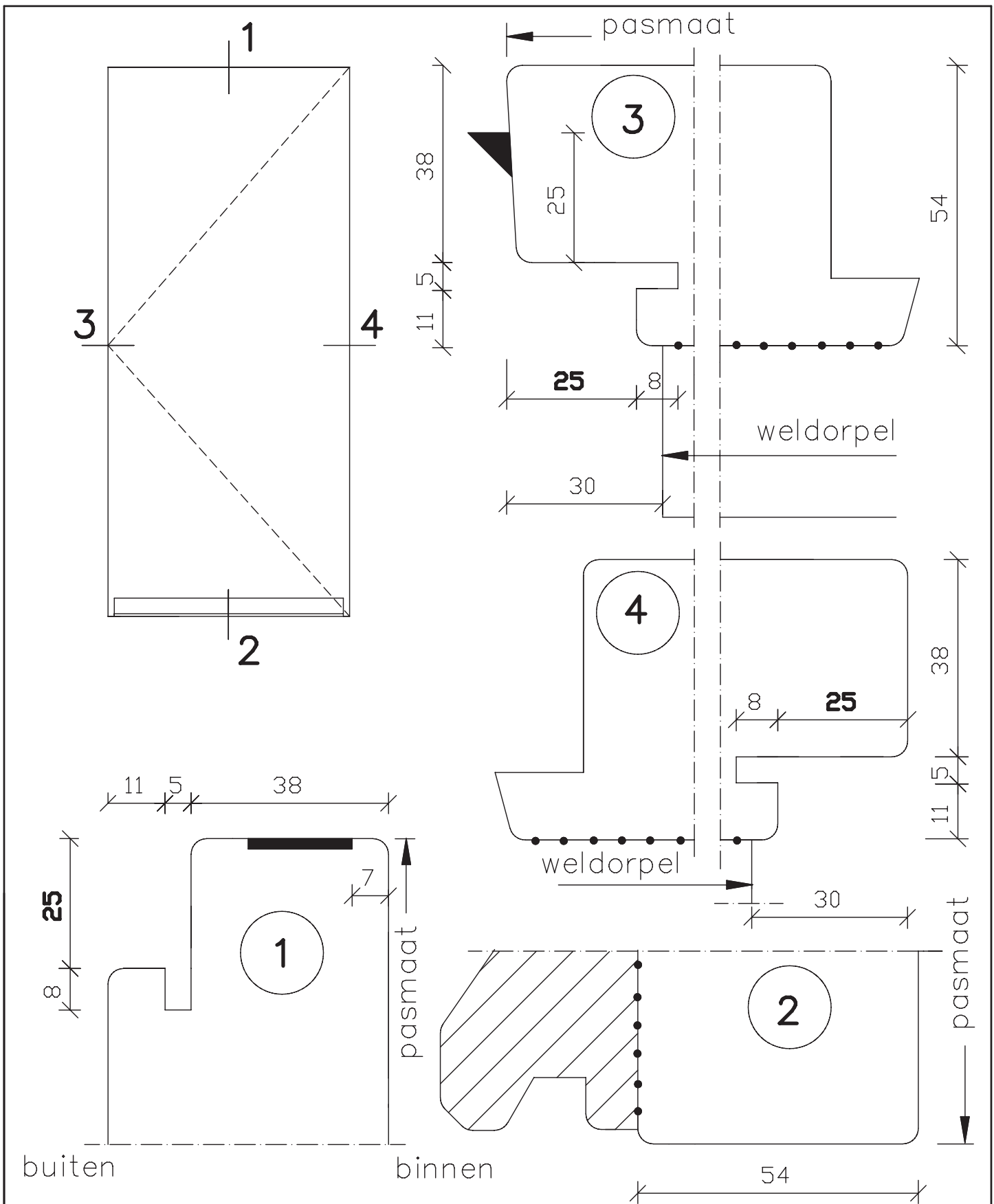

Kaderprofiel: Deventer b.v.t.  
 Grafiet opsch. band 2x20mm



	pas- en arm met kader 30 min. b.v.t. 54mm dik binnendraaiend	Blad:
maten in mm		957
sept. 2013		S